

MELBOURNE

2020

Royal Exhibition Building

30 July - 2 August

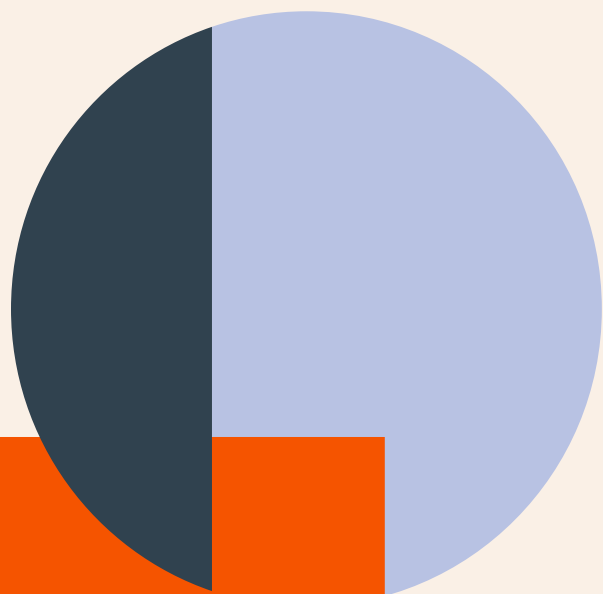
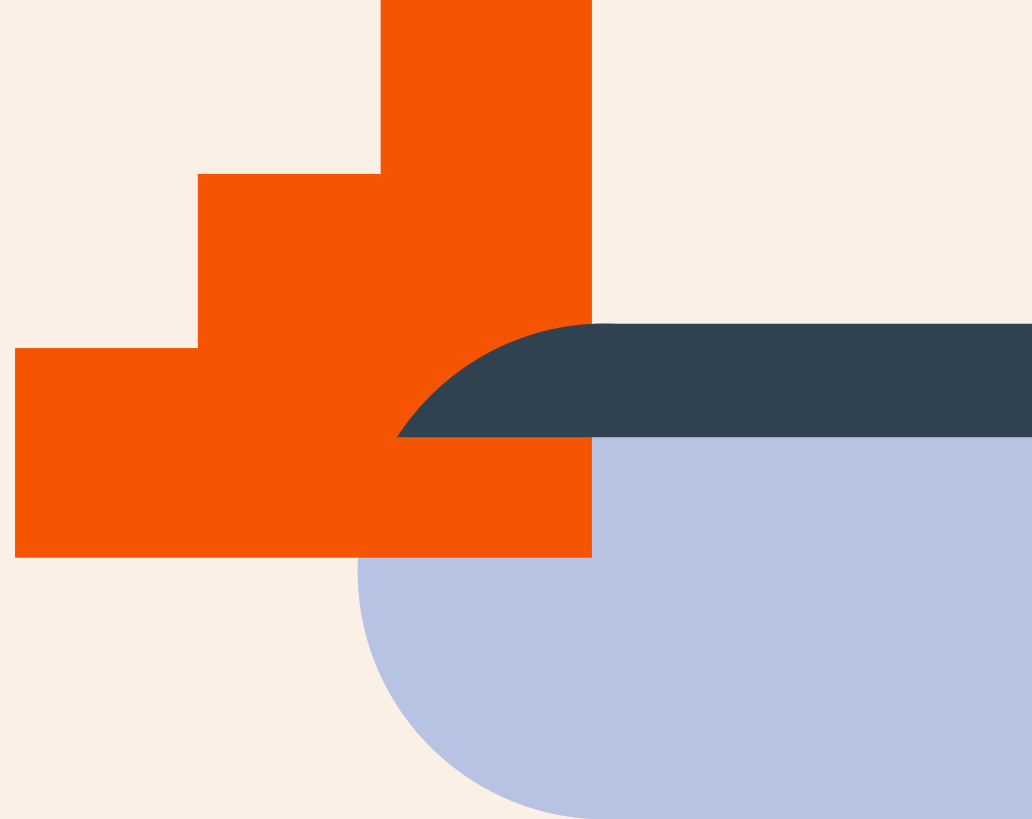

in life
in style.



It's simple really. Life Instyle was created with one simple goal – to celebrate and elevate makers and creatives doing great things.

We provide the opportunity to connect brands with the retailers, stylists and media who will help propel them into their next level of success. And what better way than to create an epic event experience that brings all of that together under one roof.

Life Instyle is first and foremost about discovery – a place to source from some of the world's best curated collections of well designed, well intentioned products. But it's also more than that. Life Instyle is about connection – a platform for like-minded creatives to come together and feel supported and nurtured on their way to greatness.

Along the way, we at Life Instyle promise to nurture, educate, inspire and stand with them, shoulder-to-shoulder as their partners in creative collaboration.



2 Cities

12,000 + Visitors

800 + Brands

20 Product Categories

80,000 + Community Reach

*Figures are a combined representation of both our Sydney and Melbourne events.
For individual numbers for each event, please speak with our team

Our trade show is a go-to destination where carefully curated products and the brilliant business minds behind them can learn and thrive.

Business conducted.

88% of exhibitors are likely to conduct business with someone they met while at Life Instyle.

83% of exhibitors met new customers at the show.

Top reasons for exhibiting.

1. Delivers **MORE NEW LEADS** than any other sales or marketing option.
2. Delivers **HIGHER QUALITY LEADS** than any other sales or marketing option.
3. Participating **ELEVATED MY BRAND STATUS**

Visitor insights.

Yearly buying budget

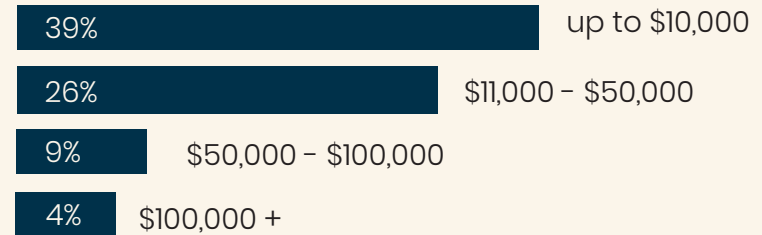

Where they came from.

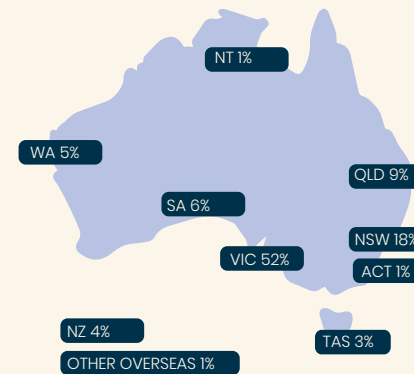

What they wanted to see.

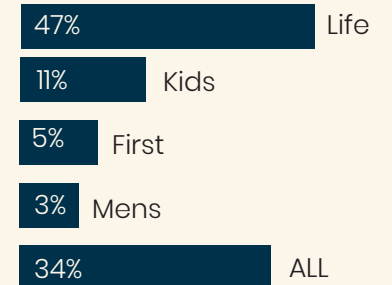

About their business.

61% of visitors are either a director, owner or partner

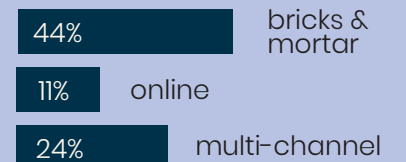

WHO WE ARE:

A small team, with a global reach and a passion to propel good brands into greatness.

WHAT WE DO:

We bring together a like-minded community of creatives to connect and discover.

HOW WE DO IT:

A trade expo experience that defies tradition through next-level creativity, curation and collaboration.

WHY WE DO IT:

To elevate meaningful products into the hands of those who want them.



A divine mix of product categories to please all retailers, media and stylists...

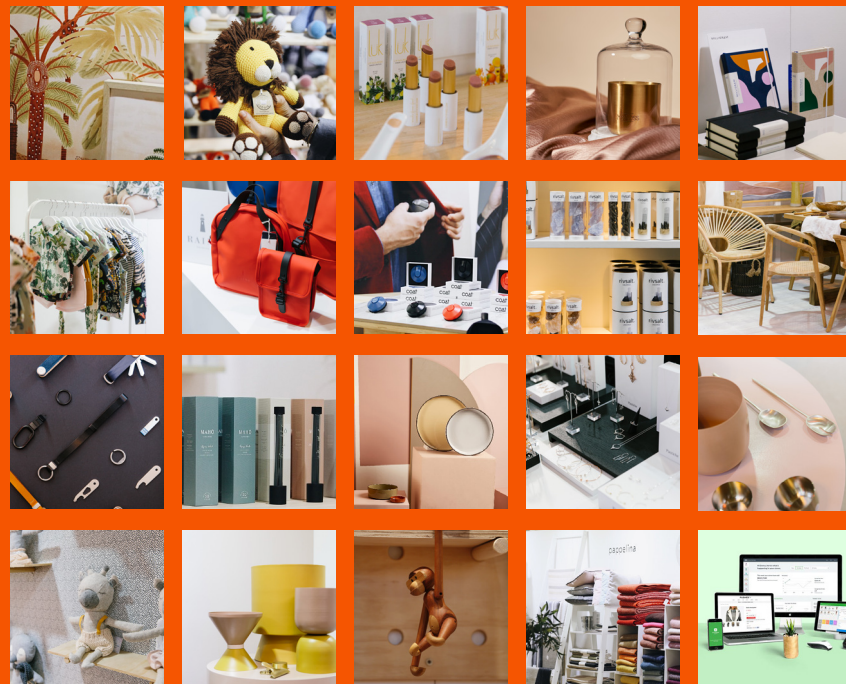

- Art
- Babies & Newborn
- Beauty & Grooming
- Body, Bath & Fragrance
- Books & Stationery
- Fashion & Accessories – Kids
- Fashion & Accessories – Women’s
- Fashion & Accessories – Men’s
- Food & Beverage
- Furniture & Lighting
- Gadgets & Tech
- Health & Wellbeing
- Homewares
- Jewellery
- Kitchen & Dining
- Nursery
- Outdoor & Garden
- Pets
- Retail Solutions



The Royal Exhibition Building is a piece of Australian and world history.

Life Instyle Melbourne is proud to call the Royal Exhibition Building home.

This magnificent Royal Exhibition Building is beautiful inside and out. As the oldest surviving building from the Great Exhibition era that is still operating as an exhibition hall, it is a true landmark of Melbourne.

With a meticulously-restored interior, Life Instyle's home at the Royal Exhibition Building elevates the quality that exhibitors and buyers have come to love and expect of us.



**first
instyle.**

First Instyle is a feature installation within Life Instyle. Showcasing new and emerging design talent from around the country!

First Instyle provides a unique opportunity, for up-and coming designers to launch themselves into the retail market, with a sample of their products with our curated First Instyle space and packages.

Competition will be fierce to become one of the select group of emerging new designers, and selection to participate as part of First Instyle is based on the demonstration of the below criteria;

- Australian and NZ companies only
- Original product designers and manufacturers only, no importers or distributors
- Business must be within its first 3 years of trade
- Products are innovative and high quality in design and production
- The ability to fill bulk orders at the end of the event

Please Note: Applicants are limited to participate in First Instyle for two events only. After the second show you will be required to move into a standard Life Instyle or Kids Instyle stand.

First Instyle Package Price: \$2,444 + gst



THE NEIGHBOURHOOD

The Self-Care Society.

With a unique theme each year, The Neighbourhood 2020 is dedicated to showcasing a mix of new and original Life Instyle brands focused around specific trends and attributes and as always with style.

In 2020 our theme for The Neighbourhood is **The Self-Care Society** and we are looking for like-minded brands in the health and wellness space.

The Neighbourhood's not just for anyone!! We're looking for the best brands from the below product categories with a focus on mindful well-being:

- Health & Wellbeing
- Bath, Body & Fragrance
- Books & Stationary
- Food & Beverage
- Beauty
- Alternative Therapies

With a bespoke build to encapsulate a feeling of wellbeing and located at the front of the show, The Neighbourhood is the premium location to showcase your brand/product to over 6,000 retailers across 4 days of trade.

Stands starting from just \$6,017 + gst and a limited number of spaces, The Neighbourhood is sure to sell-out fast!



Pricing.



MELBOURNE.

2020

30 July - 2 August
Royal Exhibition Building

STAND PRICING STRUCTURE			
Stand Size	Platinum	Gold	Silver
2x2 (4sqm)	\$3,287	\$3,195	\$3,115
2.5x2.5 (6.25sqm)	\$4,484	\$4,340	\$4,215
2x3 (6sqm)	\$4,538	\$4,400	\$4,280
2.5x3 (7.5sqm)	\$5,277.50	\$5,105	\$4,955
3x3 (9sqm)	\$6,017	\$5,810	\$5,630
3x4 (12sqm)	\$7,671	\$7,396	\$7,155
3x5 (15sqm)	\$9,415	\$9,070	\$8,770
3x6 (18sqm)	\$11,159	\$10,745	\$10,385
3x7 (21sqm)	\$12,813	\$12,330	\$11,910
3x8 (24sqm)	\$14,557	\$14,005	\$13,525
3x9 (27sqm)	\$16,301	\$16,580	\$15,140
3x10 (30sqm)	\$17,955	\$17,265	\$16,665
First Instyle	\$2,440		

All prices exclude GST | Additional \$275 surcharge for corners.

- THIS PRICE INCLUDES:**
- 2.4m high back wall
 - 1 x wall mounted light per 1.5m of walling
 - Print listing in event Lookbook & Handbook
**subject to booking deadline*
 - Digital listing in the online directory
**live throughout the campaign*
 - Emperia lead scan app to use at the show
 - Public liability insurance

STAND EXMAPLE (3x3)

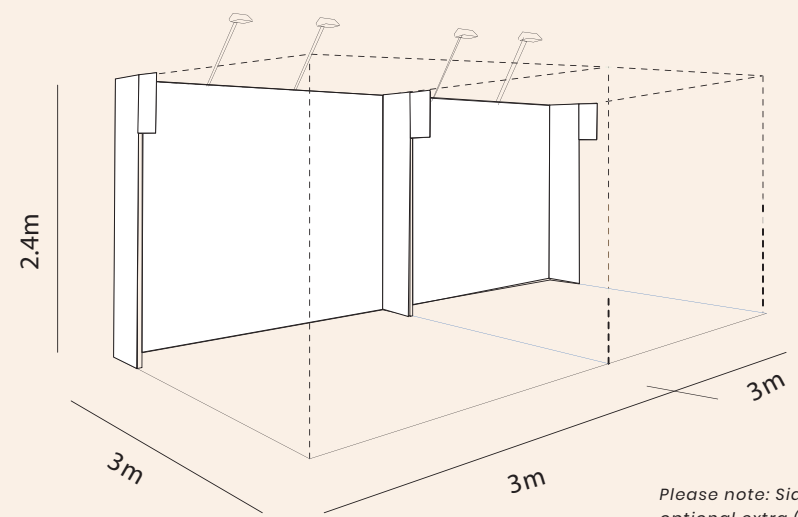

Please note: Side walls are an optional extra (\$299 + gst)

THE FINE PRINT: Life Instyle is committed to a high standard in exhibitor stand designs. We keep the show open-planned so visitors don't feel cramped and encourage you to get creative when designing your space. Please keep in mind the strict height restrictions when designing your stand. Back wall 2.4m high, side walls: 1.5m high, front stand: 1.5m high. Side walls are not included in a stand package, but can be added at an additional cost.

JOIN THE FAMILY.

Still not sure if Life Instyle is for you?

Here's what we look for in a brand to clarify whether we are the right fit for each other.

We are not a flash in the pan. We look for longevity in two senses of the word.

No Fads. We love style-led, purposeful products that will be loved for many years.

No Faux. We love products that are designed and produced with the highest intention, quality and originality, so that they will last for these loved-up years.

If it's a yes from you, it's a yes from us...

- Are your products high quality in design and production?
- Are your products well designed and well-intentioned?
- Are your products meaningful and purpose-led?
- Can your products be presented beautifully?
- Are you passionate about your craft?
- Do you have a story you're prepared to share?

We love products that are...

- Australian designed and owned
- Sustainably produced
- Ethically produced
- Cruelty free and socially conscious
- Fair trade
- Innovative
- Original and unique

Sound like you? Then let's talk more.

Contact our team or apply online [here](#).



SINEAD KAVANAGH
Sales Manager

sinead.kavanagh@reedexpo.com.au
02 9422 8694



MAYA OXFORD
Account Manager

maya.oxford@reedexpo.com.au
02 9422 2538



Organised by Reed Exhibitions Australia
Tower 2, 475 Victoria Avenue, Chatswood NSW
02 9422 8686 | info@lifeinstyle.com.au
ABN 47 000 146 921

